Section 13: Interpolation

VMC Interpolation

Modes

Linear Interpolation

Linear Interpolation is used to generate motion along a line, at a specified feed rate. The linear mode is established by the G1 code. The VMC control can move up to 5 axes simultaneously, completing the movement at a point determined by the X, Y, Z, A, and B words.

EXAMPLE:

```
N1 O1
N2 M6 T1
N3 G0 G90 S2000 M3 E1 X0 Y0 A0 B0
N4 H1 Z.1 M8
N5 G1 Z-.25 F5.
N6 G1 G91 X1. F10.
N7 X1. Y1.
N8 X1. Y1. Z1. A360. B90.
```

According to the sample program above: Block N6 moves the X axis linearly (G1 mode) 1.0 inch at a feed rate of 10 IPM. Block N7 moves the X and Y axes together forming an angular cut. Block N8 moves all possible axes together. The G1 code will use the last feed rate established in the program with the F# word. The F# word is modal and is only canceled by another F# word. The F# will remain in effect throughout the program until another F# word is used. The F# word can appear on any line with other codes as long as the other codes have no restrictions.

G1 is modal and is only canceled by a G0 code. The G1 must be used again after using a G0 code in the program. A G2/G3 code will not cancel a G1 code. This means that if a G2 or G3 is used it is not necessary to re-state the G1 on the following line. Also, if the arc center is not described, then a straight line will be generated.

Note: Maximum program feedrate at 100% is 400 IPM for machines capable of 900 IPM rapid traverse. The maximum program feedrate at 100% is 250 IPM for machines capable of 400 IPM rapid traverse.

Circular Interpolation

Circles and arcs are described by the start point, the end point, direction and distance from the start point to the center of the circle, and the arc direction. Any arc or circle may be programmed with two lines.

Note: The largest programmable radius is 399.9999 inches and with CRC 99.9999 inches.

- 1) The first line represents the move to position to the start point of the arc. This move could be a rapid move, a linear move, or the end of another circular move.
- 2) The second line (the circular move) includes the end point, arc center description, and arc direction. This move is made at the current feed rate.

XY (end point), IJ (arc center), G2/G3 (arc direction)

The end point, arc center, and direction around are described on the next three pages.

Note: Maximum program feedrate at 100% is 400 IPM for machines capable of 900 IPM rapid traverse. The maximum program feedrate at 100% is 250 IPM for machines capable of 400 IPM rapid traverse.

End Point

The end point is described differently for G90 and G91. In both cases either the X or Y or both X and Y can be used. Similar to a linear move or rapid move, only the axis that has a difference between the start point and the end point must be included in the end point description.

EXAMPLE: G90

In the absolute mode, the end point is described as the absolute distance from the home position of the part to the end point of the arc.

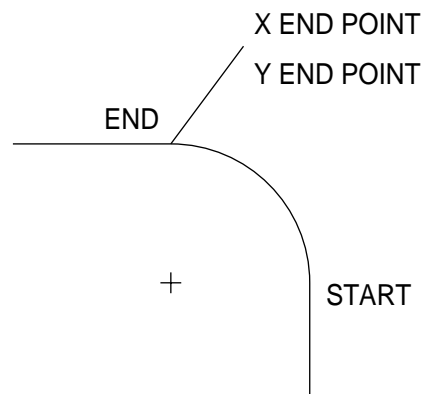

Figure 13-1 G90

G91

In the incremental mode, the end point is described as the direction and distance from the start point of the arc to the end point of the arc.

Put a pencil on the starting position of the arc and draw arrows, first horizontally along the X axis then vertically along the Y axis to the end point to help visualize the direction from start to end.

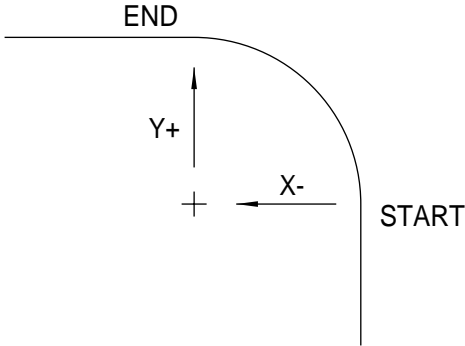

Figure 13-2 G91

**Arc Center
G90 and G91**

The arc center description is the same for G90 and G91.

The arc center is the direction and distance from the start point of the arc to the center point of the arc. Put a pencil on the starting position of the arc and draw arrows, first horizontally along the X axis then vertically along the Y axis to the center point to help visualize the direction from start to center.

For the X axis direction description to the center use the letter I.

For the Y axis direction description to the center use the letter J.

If the circle begins at the start of a quadrant, only an I or J is required. If the circle begins within the quadrant, both I and J are required.

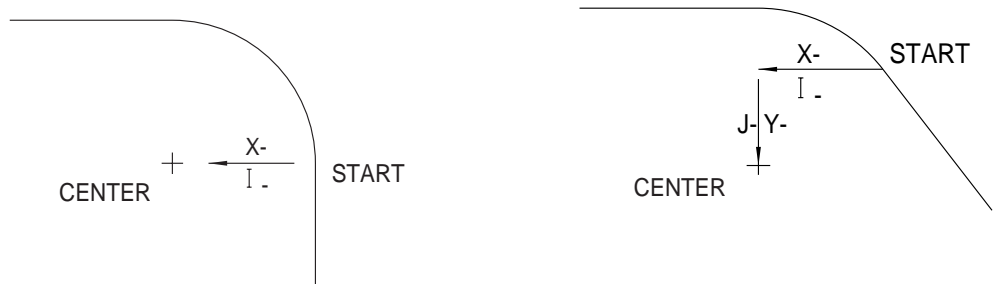

Figure 13-3

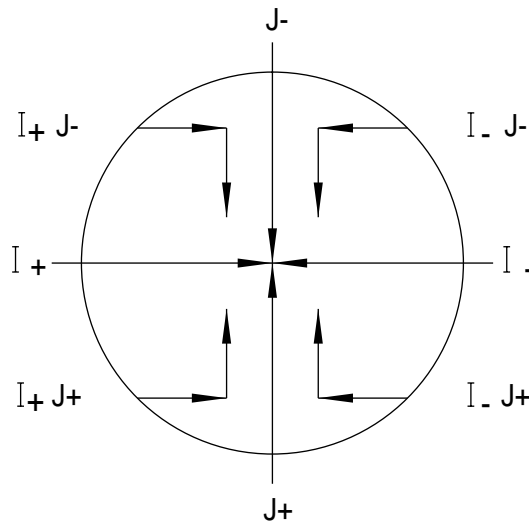

Figure 13-4

Arc Direction

The G2 code is used when the arc direction is clockwise, G3 is used for arcs in a counterclockwise direction.

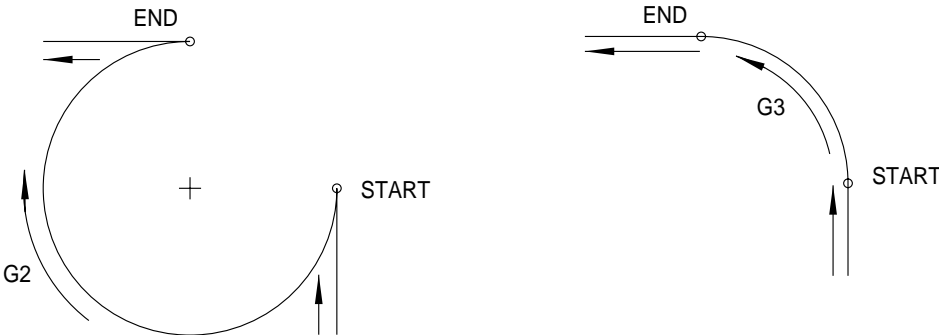

Figure 13-5 Arc Direction

Circle Examples

The following are examples of various programmed arcs in absolute (G90) and incremental (G91) modes.

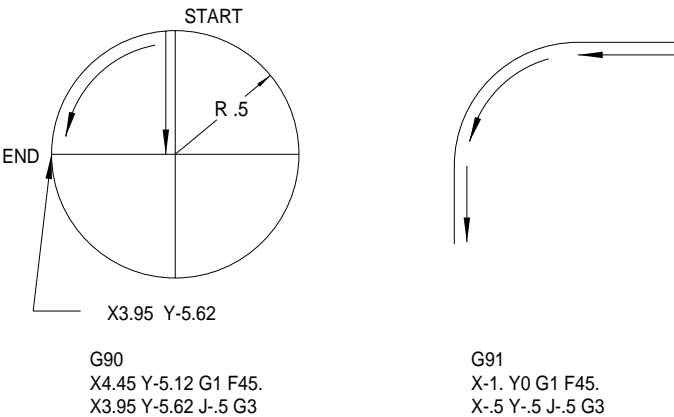
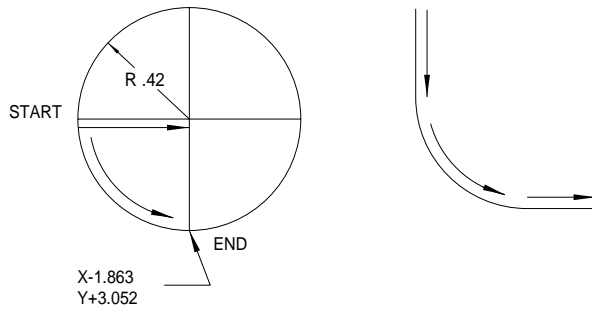

Figure 13-6 Circle Examples (1)



```
G90
X-2.283 Y2.632 G1 F45
X-1.863 Y3.052 I.42 G3
```

```
G91
X0 Y-.5 G1 F45
X.42 Y-.42 I.42 G3
```

Figure 13-7

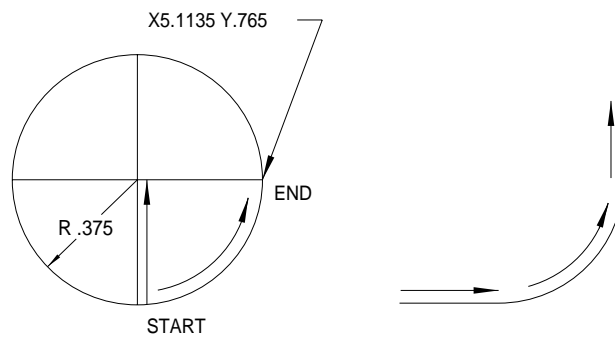

```
G90
X4.7385 Y.39 G1 F45.
X5.1135 Y.765 J.375 G3
```

```
G91
X.5 Y0 G1 F45.
X.375 Y.375 J.375 G3
```

Figure 13-8 Circle Examples (3)

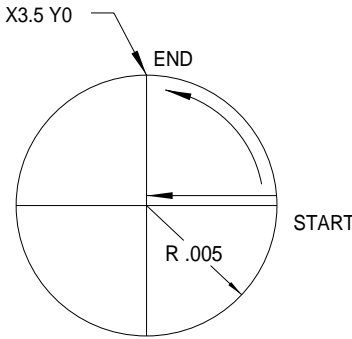

```
G90
X3.505 Y-.005 G1 F45.
X3.5 Y0 I-.005 G3
```

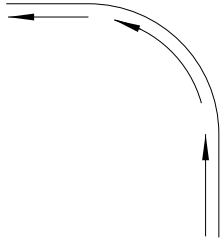

```
G91
X0 Y1. G1 F45.
X-.005 Y.005 I-.005 G3
```

Figure 13-9 Circle Examples (4)

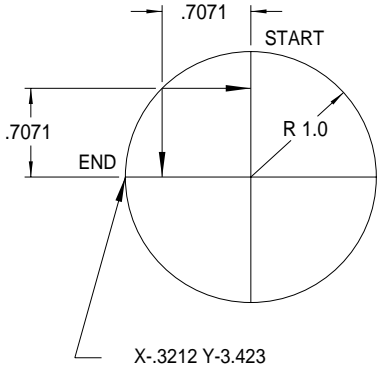

```
G90
X-.0283 Y-2.7159 G1 F45.
X-.3212 Y-3.423 I.7071 J-.7071 G3
```

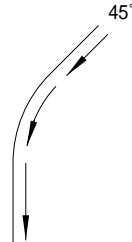

```
G91
X-.5 Y-.5 G1 F45.
X-.2929 Y-.7071 I.7071 J-.7071 G3
```

Figure 13-10 Circle Examples (5)

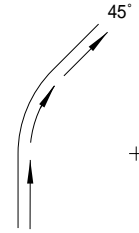
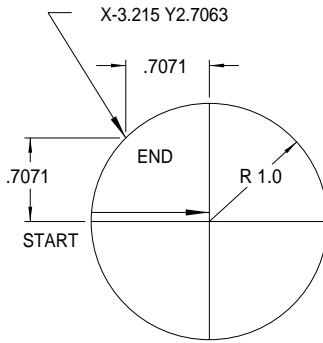

```
G90
X-3.5079 Y1.9992 G1 F45.
X-3.215 Y2.7063 I1. G2
```

```
G91
X0 Y.5 G1 F45.
X.2929 Y.7071 I1. G2
```

Figure 13-11 Circle Examples (6)

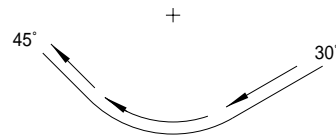
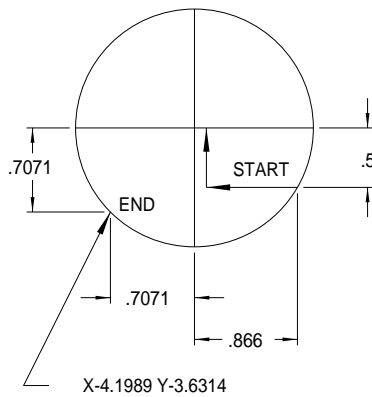

```
G90
X-2.6258 Y-3.4243 G1 F45.
X-4.1989 Y-3.6314 I-.866 J.5 G2
```

```
G91
X-.25 Y-.433 G1 F45.
X-1.5731 Y-.2071 I-.866 J.5 G2
```

Figure 13-12 Circle Examples (7)

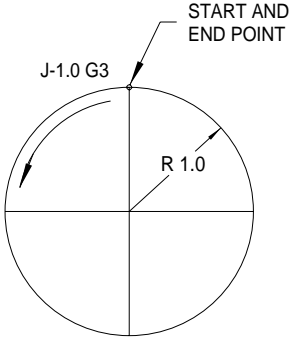

Figure 13-13 Circle Examples (8)

Full circles require the move to the start/end point and either the I or J, depending on the start point moved to, and the direction around.

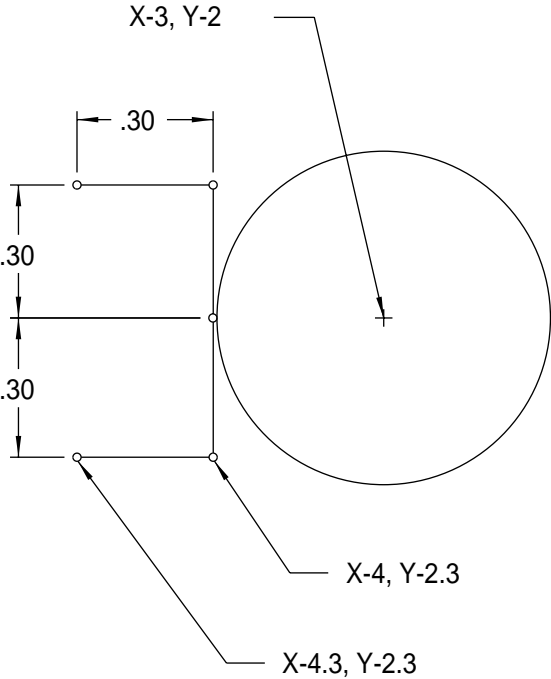

Figure 13-14 Full Circles

Circular Boss Example

```

M5 M9
G90 G0 H0 Z0
M6 T3 (TOOL #3, .5 2FL EM
G90 G0 S8000 M3 E1 X-4.3 Y-2.3
H3 D3 Z.1 M8

```

G8
 Z-.245 G1 F10.
 X-4. G41 F50.
 Y-2.
 I1. G2
 Y-1.7
 X-4.3 G40
 Y-2.3 Z-.25
 G91 (G91 USED FOR EXAMPLE ONLY)
 X.3 G41
 Y.3
 I1. G2
 Y.3
 X-.3 G40
 M5 M9
 G90 G0 H0 Z0
 M6 T4

Contoured Slot Example

M5 M9
 G90 G0 H0 Z0
 M6 T6 (TOOL #6, 3/8 (.375) 2FL
 EM
 G90 G0 S10000 M3 E1 X2. Y-1.5
 H6 D6 Z.1 M8
 Z.01 G1 F10.
 G8
 G91
 X-1. Z-.135 F30.
 X1.
 X-1. Z-.145
 X1.
 X.19 G41 F50.
 X-.19 Y.19 I-.19 G3
 X-1.
 Y-.38 J-.19 G3
 X1.
 Y.38 J.19 G3
 X-1.
 Y-.38 J-.19 G3
 X1.
 X.19 Y.19 J.19 G3
 X-.19 G40

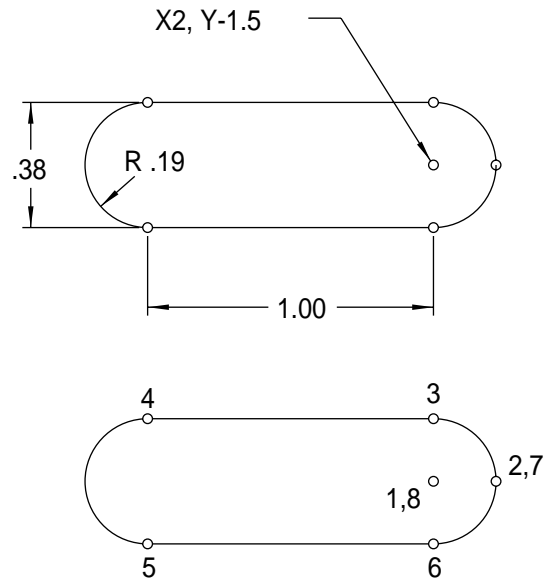

Figure 13-15 Contoured Slot Example

G90
 Z.1 G0
 G0 G90 H0 Z0

Circular Interpolation Using G18 & G19

Using **G18** (XZ plane) and **G19**(YZ plane) requires the use of K to represent the direction and distance in Z from the starting point of the circle to the circle center.

G18 Circles in the XZ plane require either the absolute or incremental end point, the I and K circle center description, and a G2/G3 arc direction. Note that G2 and G3 are reversed. The information in this section concerning the use of I and J applies to the K word.

The G18 word must appear in the program just before the circular move. The G18 is required only for the XZ circular moves. Linear XZ moves can be programmed from any plane. When cutter radius compensation is required for linear and circular XZ moves, use the G18 just before applying compensation and the compensation will be applied to the XZ axes.

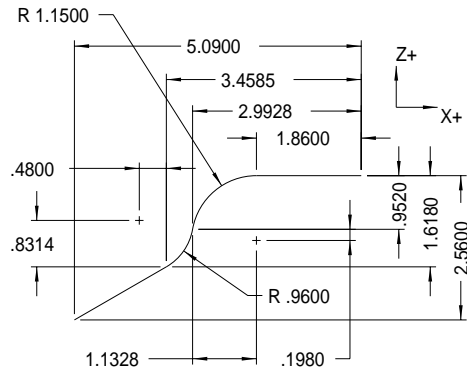

Figure 13-16

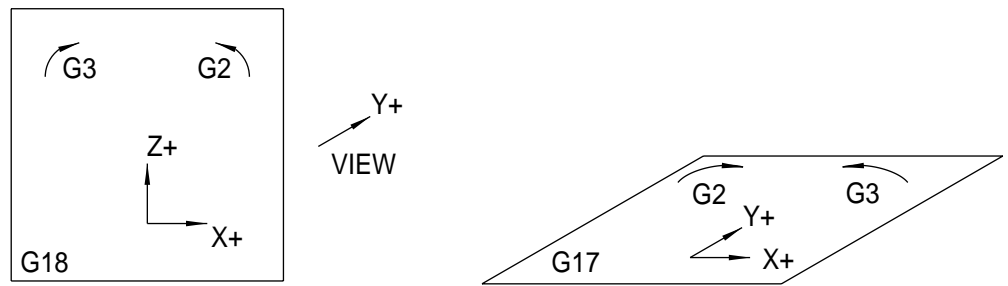

Figure 13-17

EXAMPLE: G90

```
G90 X-5.09 Z-2. G0  
G18  
Z-2.56 G42 G1  
X-3.4585Z-1.168  
X-2.9928 Z-.952 I-.48 K.8314 G2  
X-1.86 Z0 I1.1328 K-.198 G3  
X0  
Z.5 G0 G40
```

EXAMPLE: G91

```
G90 X-5.09 Z-2.  
G18  
G91  
Z-.56 G41 G1  
X1.6315 Z.942  
X.4657 Z.666 I-.48 K.8314 G2  
X1.1328 Z.952 I1.1328 K-.198 G3  
X1.86  
Z.5 G0 G40
```

G19 Circles in the YZ plane require either the absolute or incremental end point, the J and K circle center description, and the G2 or G3 description. The information in this section concerning the use of I and J applies to the K word.

The G19 word must appear in the program just before the circular move. The G19 is required only for the YZ circular moves. Linear YZ moves can be programmed from any plane. When cutter radius compensation is required for linear and circular YZ moves, use the G19 just before applying compensation and the compensation will be applied to the YZ axes.

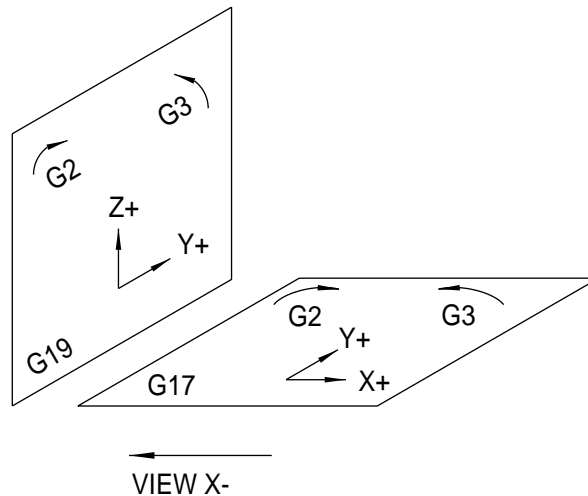
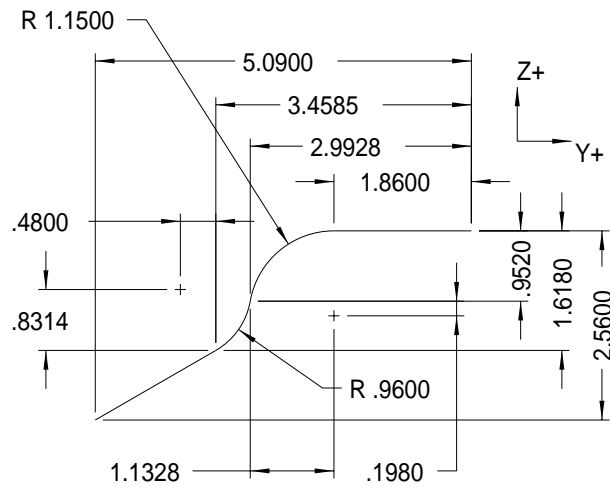

EXAMPLE: G90

```
G90 Y-5.09 Z-2.  
G19  
Z-2.56 G41 G1  
Y-3.4585 Z-1.618  
Y-2.9928 Z-.952 J-.48 K.8314 G3  
Y-1.86 Z0 J1.1328K-.198 G2  
Y0  
Z.5 G0 G40
```

EXAMPLE: G91

```
G90 X-5.09 Z-2.  
G19  
G91  
Z-.56 G41 G1  
X1.6315 Z.942  
X.4657 Z.666 J-.48 K.8314 G3  
X1.1328 Z.952 J1.1328 K-.198 G2  
X1.86  
Z.5 G0 G40
```

Circular Interpolation Using Radius Designation

An R word, which represents the radius of the circle, can be used in place of the I, J, or K arc center description. This can be used in any plane (G17, G18, G19) and with absolute or incremental in effect.

An R0 variable is used to represent the radius of the arc to be programmed. The sign (+,-) of the R0 value determines the amount of angular motion. A negative value is used for motion greater than 180 degrees. A positive value for motion equal to or less than 180 degrees. For example; R0+1. defines a one inch radius, with motion equal to or less than 180 degrees; R0-1. defines a one inch radius, with the motion greater than 180 degrees.

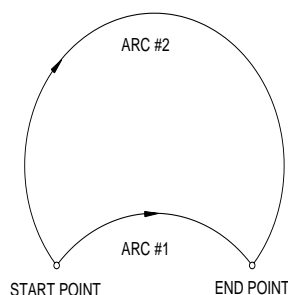

Figure 13-18

The drawing above shows two possible clockwise (G2) paths. Each has the same end point. One arc is greater than 180 degrees, the other less than 180 degrees. Use R0+1.0 to move along arc #1 or use R0-1.0 to move along arc #2.

G90 X3.623 Y-2.173 R0+.75 G2 (for arc #1)
X3.623 Y-2.173 R0-.75 G2 (for arc #2)

G91 X.65 Y0 R0+.75 G2 (for arc #1)
X.65 Y0 R0-.75 G2 (for arc #2)

Note: When using radius designation, the circular motion must be less than 360 degrees. Full circles are not allowed.

The radius value can be represented by a parameter:

X1. Y1. R0+R1 G3

The R0 value will be the R1 parameter value. See Section 18, Macros, for more information concerning the use of parameters.

Helical Interpolation

Helical moves are used in various situations. Thread milling is one good example. Helical moves can be used for roughing the walls of a bore and for entering a pocket with a bottom cutting end mill. This type of motion can be used to replace a pilot hole drilled to enter a bore or a pocket.

When G17 (XY plane) is coded, the perpendicular axis is the Z axis. A helical move in G17 would be an XY circular move with a Z axis move coded in the same line as the circle. For G18 (XZ plane), the perpendicular axis is the Y axis. A helical move in G18 would be an XZ circular move with a Y axis move in the same line. For G19 (YZ plane), the perpendicular axis is the X axis. A helical move in G19 would be a YZ circular move with an X axis move in the same line. For any of the planes selected with G17, G18, or G19, the perpendicular axis move finishes at the same time that the circular move finishes.

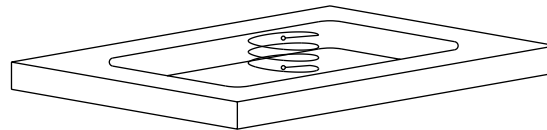

Figure 13-19

EXAMPLE: *(TOOL #1, 3/8 2FL EM, CENTER CUTTING)*
M6 T1
G90 G0 S8000 M3 E1 X2. Y-1.5 *This is the move to the center of the pocket*
H1 D1 Z.05 M8
X2.3 Z0 G1 F30. *This is the move to the start point of the circle and to the top*
G91
I-.3 G3 Z-.05 *This is the first helical move*
I-.3 G3 Z-.05
I-.3 G3 Z-.04 *At the end of this move the tool is .14 deep*
X-.3 F40. *This move is back to the center of the pocket*
L9601 R0+40. R1+.01 R2+2.98 R3+1.98 *Rectangular pocket routine*
X.3 *This move is to the start of the circle*
I-.3 G3 Z-.010 *This last helical move is to the -.15 finished floor depth*
X-.3 F50. *This move is back to center*
L9601 R0+50. R1+.01 R2+3. R3+2. *Rectangular pocket routine*
M5 M9
G90 G0 H0 Z0

Repeating Helical Moves

Helical moves are usually made by repeating subroutines, subprograms, or copying lines in the program.

Examples Using Copied Lines

```
G90
X5.5 G1 G41
I-.5 G3 Z-.1
I-.5 G3 Z-.2
I-.5 G3 Z-.3
X5. G40
```

Note: The circular moves remain the same, however the absolute Z axis positions must change in each line.

```
G91
X.5 G1 G41
I-.5 G3 Z-.1
I-.5 G3 Z-.1
I-.5 G3 Z-.1
X-.5 G40
or
G91 X.5 G1 G41
I-.5 G3 Z-.1 L3
X-.5 G40
```

Note: The circular and Z axis moves remain the same in each line. The copy command can be used to copy each incremental helical move.

Examples Using Line Repetitions

```
G90
X5.5 G1 G41
G91 I-.5 Z-.1 G90 L3
X5. G40
```

Note that the L3 is used here to repeat the helical move. This example can only be used in a main program. The L line repeat code is restricted to the main program. The G91 in the beginning of the line establishes the incremental mode for the helical move. The G90 in the end of the line establishes the absolute mode for the next line. This will work if it is typed into the control in this exact order.

Examples Using Subroutines and Subprograms

EXAMPLE: Using Subroutines

```

L100 (SUB FOR HELICAL MOVES DOWN INTO POCKET
G91 I-.5 G3 Z-.1 CRC is not applied here
M17
L200 (SUB FOR POCKET
G91 D1 The diameter of the tool must be in tool table to function properly
L104 The helical move in subroutine L100 is repeated four times here (Z-.4)
L9601 R0+10. R1+.015 R2+2.96 R3+2.96 Roughing the pocket
X1.5 G41 G1 Finishing the pocket, apply CRC here
Y.98
X-.52 Y.52 I-.52 G3
X-1.96
X-.52 Y-.52 J-.52 G3
Y-1.96
X.52 Y-.52 I.52 G3
X1.96
X.52 Y.52 J.52 G3
Y.98
X-1.5 G40 Cancel CRC
G90 Z.1 G0 Z up to move to the next pocket location
M17
M30
*****MAIN PROGRAM*****
M6 T1
G0 G90 S200 M3 E1 X0 Y0
H1 Z.1 M7
G1 Z.05 F10.
L201 Call subroutine 200 1 time
Move to next fixture and repeat

G0 G90 H0 Z0
E0 X0 Y0
M2

```

Note that the helical move was placed in a subroutine. The first line of sub L200 has the G91 code needed for L100 to be repeated to get the incremental Z move down.

EXAMPLE: Using Subprograms

```

O1 (SUB FOR HELICAL MOVE
G91 I-.5 G3 Z-.1 CRC is not applied here

```

```
M99
O2 (SUB FOR POCKET
G91 D1 The diameter of the tool must be in tool table to function properly
M98 P1 L4 The helical move in subprogram O1 is repeated here four times (Z-
.4)
L9601 R0+10. R1+.015 R2+2.96 R3+2.96 Roughing the pocket
X1.5 G41 G1 Finishing the pocket, apply CRC here
Y.98
X-.52 Y.52 I-.52 G3
X-1.56 G40 Cancel CRC
G90 Z.1 G0 Z up to move to the next pocket location
M99
```

Note that the helical move was placed in a subprogram. The first line of sub O2 has the G91 code needed for O1 to be repeated to get the incremental Z move down.

Cutter Radius Compensation with Helical Moves

Cutter radius compensation can be used with a helical move. CRC must be turned on before the helical move. Compensation is applied to the axes of the selected plane. For example in G17 compensation is applied to the X and Y axes and no compensation would be applied to the Z axis. The same is true for the G18 plane and the G19 plane.

Here is an example of applying compensation and then making the helical move. The helical move is used to rough the bore and a circular move is made at the end to finish the bore. Note that a drill was not needed as a pilot for the end mill. Because the tool is climb cutting down the wall of the bore, the tool is automatically leaving stock for the finish cut at the end.

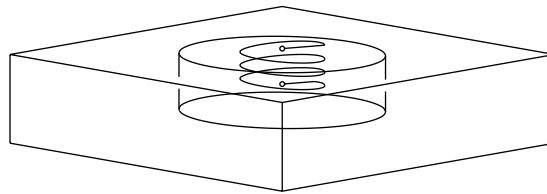

Figure 13-20

EXAMPLE: *(TOOL #1, 3/4 2FL EM, BOTTOM CUTTING
M6 T1
G90 G0 S5000 M3 E1 X2. Y-2.
H1 D1 Z.05 M8
X2.5 Z0 G1 F25. Tool down to the top of the part
X3. G41 Comp on to the edge of the one two inch bore
G91 I-1. G3 Z-.3 L3 Helical down -.9 from the top
I-1. G3 Z-.13 Helical down -1.03 from the top
I-1. G3 L2 Two finishing passes
G90 X2. G40 G0 Comp off back to the center of the bore
M5 M9
G90 G0 H0 Z0*

Partial Arcs and Helical Moves

Helical moves can be made with any circular move, including full circles and partial arcs.

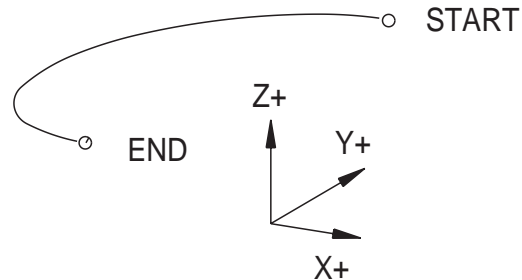

Figure 13-21

EXAMPLE: *G91*
Y.19 G41 G1
Y-.38 J-.19 G3 Z-.05 Helical move with a partial arc
X1. Z-.05 Linear XZ move
Y.38 J.19 Z-.05 Helical move with a partial arc
X-1. Z-.05 Linear XZ move
Y-.38 J-.19 G3 Finish moves for slot
X1.
Y.38 J.19 G3
X-1.
Y-.19 G40

Thread Milling

Threads can be cut using a single point thread mill or with a thread hob. A single point thread mill can be used for any lead thread, where a thread hob is ground for a specific lead. Thread hobs and single point cutters are available as carbide inserts. Inserts can also be purchased for pipe threads.

- 1) A boss must be cut to the major diameter of the thread for an outside diameter (OD) thread, and a bore must be cut to the minor diameter of the thread for an inside diameter (ID) thread.
- 2) Determine the lead of the thread to be cut. The lead represents the distance from thread to thread.
 - a. Lead (inches) = 1 / threads per inch
 - b. Lead (metric) = (mm/threads per inch) the lead is the 2.0, or 2.0mm lead. To convert to inches multiply the lead times .03937 to get the lead distance in inches.

EXAMPLE: 1 1/16 - 28 thread

Lead = 1 / 28 Lead = .0357

Cutting an OD Thread

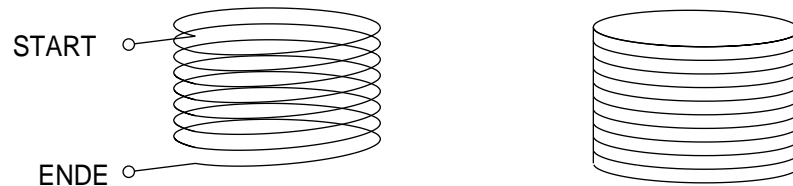

To cut a right handed OD thread:

- 1) Start at the top of the boss for an OD thread.
 - a. Turn comp on, moving up to the minor diameter.
 - b. Helical cut down using G2 and a Z- (lead) for each thread.
 - c. Move away from the minor diameter turning comp off.

The tools are set at the top of the part. The thread is located at X0 Y0. The amount of thread to cut is .500

(OD Thread example 1 1/16 - 28 3A)

Major dia. - 1.0625/1.056

Minor dia. - 1.0187

N46 (TOOL #5 3/4 DIA SINGLE POINT CARB THREAD MILL (CRC)

N47 M6 T5

N48 G90 G0 S10000 M3 X-1. Y0

N49 H5 Z.0357 M7

N50 X-.5094 G41 G1 F25.

```
N51 G91  
N52 I.5094 G2 Z-.0357 L15  
N53 G90  
N54 X-1. G40 G0  
N55 M5 M9
```

Line N48 moves the tool to a safe position to bring the tool down away from the boss.

Line N49 brings the tip of the threading tool to one thread above the boss.

Line N50 turns comp on while moving up to the minor diameter.

Line N52 is the helical cut down, in incremental mode. The L15 in line 52 repeats the line fifteen times. This is why it is in incremental mode. Each repeat represents the next thread.

Line N54 moves the tool away from the diameter turning comp off.

Cutting an ID Thread

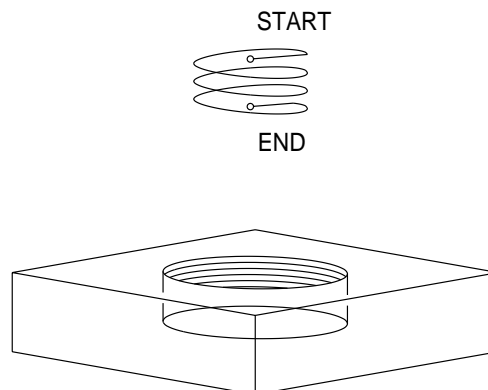

Figure 13-22

To cut a right handed ID thread:

- 1) Start at the bottom of the bore.
 - a. Turn comp on moving up to the major diameter.
 - b. Helical cut up using G3 and a Z+(lead) for each thread.
 - c. Move away from the diameter turning comp off.

The tools are set at the top of the part. The thread is located at X0 Y0. The amount of thread to cut is .500

(ID Thread example 1 1/16 - 28 2B)

Major dia. - 1.0625

Minor dia. - 1.0240/1.0301

N46 (TOOL #5 3/4 DIA SINGLE POINT CARB THREAD MILL (CRC)

N47 M6 T5

N48 G90 G0 S10000 M3 X0 Y0

N49 H5 Z.1 M7

N50 Z-.5 G1 F50.

N51 X.5313 G41 G1 F25.

N52 G91

N53 I-.5313 G3 Z.0357 L15

N54 G90

N55 X0 G40 G0

Line 48 moves the tool to the center of the hole.

Line 50 brings the tip of the threading tool to the depth of the first thread. Line 51 turns comp on while moving up to the major diameter.

Line 53 is the helical cut up, in incremental mode. The L15 in line 53 repeats the line fifteen times. This is why it is in incremental mode. Each repeat represents the next thread.

Line 55 moves the tool away from the diameter turning comp off.